



ARRL Periodicals Archive – Search Results

A membership benefit of ARRL and the ARRL Technical Information Service

ARRL Members: You may print a copy for personal use. Any other use of the information requires permission (see Copyright/Reprint Notice below).

Need a higher quality reprint or scan? Some of the scans contained within the periodical archive were produced with older imaging technology. If you require a higher quality reprint or scan, please contact the ARRL Technical Information Service for assistance. Photocopies are \$3 for ARRL members, \$5 for nonmembers. For members, TIS can send the photocopies immediately and include an invoice. Nonmembers must prepay. Details are available at www.arrl.org/tis or email photocopy@arrl.org.

QST on CD-ROM: Annual CD-ROMs are available for recent publication years. For details and ordering information, visit www.arrl.org/qst.

Non-Members: Get access to the ARRL Periodicals Archive when you join ARRL today at www.arrl.org/join. For a complete list of membership benefits, visit www.arrl.org/benefits.

Copyright/Reprint Notice

In general, all ARRL content is copyrighted. ARRL articles, pages, or documents--printed and online--are not in the public domain. Therefore, they may not be freely distributed or copied. Additionally, no part of this document may be copied, sold to third parties, or otherwise commercially exploited without the explicit prior written consent of ARRL. You cannot post this document to a Web site or otherwise distribute it to others through any electronic medium.

For permission to quote or reprint material from ARRL, send a request including the issue date, a description of the material requested, and a description of where you intend to use the reprinted material to the ARRL Editorial & Production Department: permission@arrl.org.

QST Issue: Aug 1996

Title: "Intermod"--A Modern Urban Problem

Author: Ed Hare, KA1CV

[Click Here to Report a Problem with this File](#)

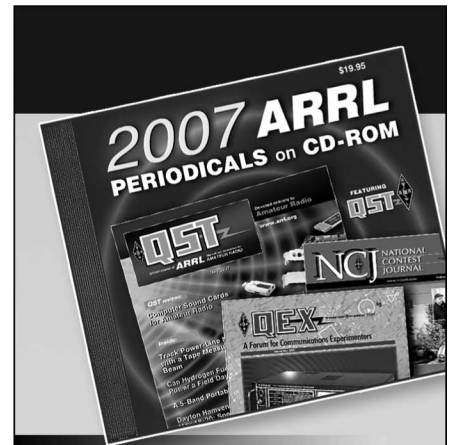

ARRL Periodicals on CD-ROM

ARRL's popular journals are available on a compact, fully-searchable CD-ROM. Every word and photo published throughout the year is included!

- **QST** The official membership journal of ARRL
- **NCJ** National Contest Journal
- **QEX** Forum for Communications Experimenters

SEARCH the full text of every article by entering titles, call signs, names—almost any word. SEE every word, photo (including color images), drawing and table in technical and general-interest features, columns and product reviews, plus all advertisements. PRINT what you see, or copy it into other applications.

System Requirements: Microsoft Windows™ and Macintosh systems, using the industry standard Adobe Acrobat Reader® (included).

ARRL Periodicals on CD-ROM

\$19.95* per set.

- 2007 Edition, ARRL Order No. 1204
- 2006 Edition, ARRL Order No. 9841
- 2005 Edition, ARRL Order No. 9574
- 2004 Edition, ARRL Order No. 9396
- 2003 Edition, ARRL Order No. 9124
- 2002 Edition, ARRL Order No. 8802
- 2001 Edition, ARRL Order No. 8632
- 2000 Edition, ARRL Order No. 8209
- 1999 Edition, ARRL Order No. 7881
- 1998 Edition, ARRL Order No. 7377
- 1997 Edition, ARRL Order No. 6729
- 1996 Edition, ARRL Order No. 6109
- 1995 Edition, ARRL Order No. 5579

*plus shipping and handling



ARRL The national association for AMATEUR RADIO

SHOP DIRECT or call for a dealer near you.
ONLINE WWW.ARRL.ORG/SHOP
ORDER TOLL-FREE 888/277-5289 (US)

By Ed Hare, KA1CV

“Intermod”—A Modern Urban Problem

Getting squeaks and squawks from your H-T?
Are pagers crunching your mobile rig’s front end?
Here’s how intermod happens—and how to fight back!

Some old-time hams remember when VHF was quite deserted. Nearly all stations found above 50 MHz were TV and FM broadcasters. The 2-meter band was often silent, and there were relatively few VHF transmitters used by the police and businesses. With so few stations on the bands, and those stations using simple equipment (insensitive receivers), interference was unlikely.

If you use VHF today, you know that those days are gone forever. Thousands upon thousands of transmitters operate above 50 MHz for business, public service, amateur, satellite and many other uses. In addition to licensed transmitters, there are countless unlicensed transmitters, operating under FCC Part 15. It is likely that some of these radio systems will interact in undesirable ways.

When a new ham first fires up a VHF receiver and hears a few pagers in addition to the normal signals—or, even worse, hears bleeps, noises and unidentified voices across most of the band—he or she often turns to more experienced hams for an explanation. Most of these explanations blame the problem on *intermod* (intermodulation distortion, or IMD)—often with little explanation of the term.

What Is Intermod?

Communicators sometimes use the term intermod incorrectly. While intermodulation of two or more signals causes some VHF interference problems, other problems, such as front-end overload, poor IF (intermediate frequency) image rejection or IF leakage are sometimes the real culprits. Hams tend to call them all “intermod,” which complicates the explanation a bit.

In a perfect world, every amplifier would amplify signals without distortion, every mixer would convert RF signals to the IF perfectly, and a radio would hear only the desired signal. In the real world, how-

ever, all of these processes are nonlinear to some degree. This results in the creation of interference.

What does “nonlinear” mean? It means that the output voltage does not follow the input voltage perfectly. Nonlinear circuits can generate harmonics and mix signal frequencies. The RF amplifier or mixer circuits in a receiver can be somewhat nonlinear, creating additional signals from the desired signal—and perhaps others—present at the nonlinear stage.

Harmonics

When a single frequency (the *fundamental*) passes through a nonlinear circuit, distortion signals appear at integer multiples of the fundamental frequency (*harmonics*, see Figure 1). We identify each harmonic by its relation to the fundamental: The second harmonic is at two times the original frequency, the third at three times the frequency, and so forth. We use frequency multiplier circuits to produce only desired harmonics. *Unwanted* harmonics can cause interference wherever they occur, ranging from HF-transmitter harmonics that interfere with a TV, to

a 49-MHz transmitter’s third harmonic that interferes with a 147-MHz 2-meter station ($49 \times 3 = 147$).

Mixers

Mixers are nonlinear devices by design. In a typical mixer used in a superheterodyne receiver, a desired signal mixes with that from a local oscillator (LO) to produce sum and difference signals. The IF circuitry selects and amplifies either the sum or difference signal. In older radios, the IF is usually the difference frequency. Modern radios, some of which use multiple conversions, sometimes use the sum frequency.

All Mixed Up

IMD, however, is a mixing process gone bad—a form of *distortion*. Whenever two or more signals are present in a nonlinear circuit at the same time, IMD creates new, unwanted frequencies from them.

The relationships between the two signals and the resultant distortion products can be quite complex. (We’ll work with only two inputs, f_1 and f_2 , to simplify our discussion.) Signals and *their harmonics* can mix together to form still more new frequencies. Any signals created in the circuit can then mix with each other and the original signals to form a complex spectrum, indeed.

The strongest IMD products are those that involve the sum and difference of the input frequencies, the harmonics of the input frequencies, and the mixing of the harmonics with each of the original input frequencies (harmonic mixing). There are higher-order mixing relationships, but they’re more complicated than we want to discuss here.

IMD Product Orders

We often use the term *order* to describe a group of IMD products. Because IMD results from combining frequencies, we can identify each IMD product with an equation

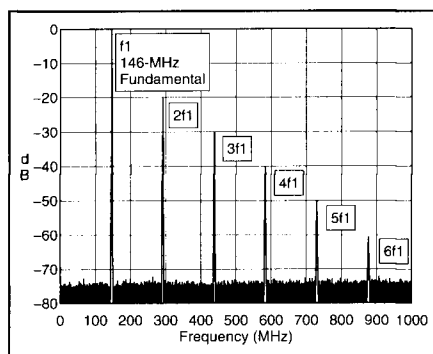

Figure 1—This 146-MHz signal contains harmonics that extend well into the UHF range.

Table 1
Orders of Some IMD Products

IMD Product	Order	IMD Product	Order
f1 + f2	2	2f1 - 2f2	4
f2 - f1		3f2 + f1	
2f1, 2f2			
2f1 - f2	3		
f1 + f2 - f3			
3f2			

describing the sums and differences of the various signals involved. For example, $f1 + f2$, $2f1 - f2$ and $3f2 - 2f1$ are three such equations. An IMD product's order is the sum of the coefficients (in the term $2f1$, 2 is $f1$'s coefficient) of the terms in the equation. Remember that, even though you don't see it, a term like "f1" has a coefficient of 1. Table 1 shows some example IMD equations and their orders. Figure 2 shows the result of a mixer circuit (or very nonlinear amplifier) generating sum and difference products.

IMD is more complex than simple sum and difference second-order relationships. A nonlinear circuit creates harmonics of all input signals, and those harmonics mix with all of the fundamental signals plus those created by the nonlinearity. Third-order IMD between paging systems causes much of the IMD problems that plague VHF operators.

Third-Order IMD

The second harmonic of $f1$ or $f2$ can mix with the other fundamental to form a product. These products are especially important because they are low-order products, and therefore relatively strong. Also, when $f1$ and $f2$ are relatively close in frequency, these products are close to $f1$ and $f2$. These equations characterize third-order products:

- Eq 1 $2f1 - f2$
- Eq 2 $2f2 - f1$
- Eq 3 $2f1 + f2$
- Eq 4 $2f2 + f1$

The first two are probably the most important to the VHF operator because the frequencies involved are so close to the desired frequency. For example, a pager on

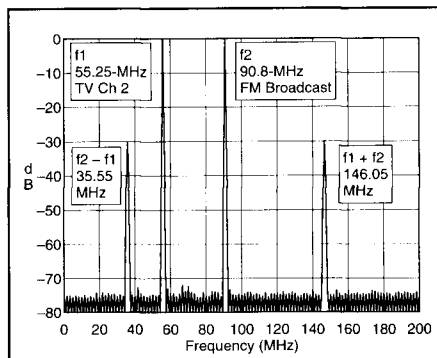

Figure 2—Here, $f1$ (55.25 MHz) and $f2$ (90.8 MHz) are present at the input of a VHF receiver, they may generate an interfering signal ($f1 + f2$) on 146.05 MHz.

153.75 MHz ($f1$) can mix with a 160-MHz ($f2$) signal to produce an interfering signal ($2 \times 153.75 - 160 = 147.5$) on the 2-meter band, according to Eq 1. Some of these frequencies are assigned to paging transmitters, which are very common in urban areas. Figure 3 shows the result of third-order IMD in a nonlinear circuit.

Higher-order products do exist. Figure 3 shows how higher odd-order products (fifth, seventh, etc) form a "Christmas-tree" pattern up and down the band.

IF Response and Image Rejection

IMD is only one of the mechanisms that can create interference. Poor IF response and poor image rejection in the VHF receiver cause some problems that operators commonly blame on intermod. All superheterodyne receivers are subject to these problems. In a superhet, a mixer circuit combines the desired signal with a local-oscillator (LO) signal. The IF then selects either the sum or difference product for further processing. The presence of unwanted signals can disturb this simple scheme.

Figure 4 illustrates a 146-MHz receiver with a 10.7-MHz IF. Ideally, a signal on 146 MHz mixes with the 156.7-MHz LO to produce a difference signal on 10.7 MHz that is identical to the original signal except for its frequency. If a signal on 167.4 MHz reaches the mixer, however, that signal also appears on 10.7 MHz ($167.4 - 156.7 = 10.7$).

The front-end filters of well-designed radios reject (attenuate) image signals, so that users hear images only when the unwanted signal is very strong. Inadequate front-end filters can pass image responses that are as strong as the desired response. Poor image rejection is more common in receivers designed to tune over a broad frequency range. For example, a ham H-T that also receives the NOAA weather broadcasts at 162 MHz is likely to have trouble rejecting IF-image signals at 165.4 to 169.4 MHz because the images lie near the receive passband.

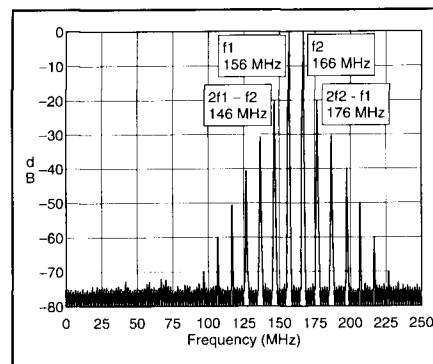

Figure 3—These pager frequencies can intermodulate to form a product in the amateur 2-meter band. If there are many pagers on different frequencies in the same area, the result can be interference across the band. This actually occurs in some major cities. This graph shows third- and higher odd-order products.

It is also possible to have an unwanted signal leak past the front end and mixer into the IF section. Then it's processed like the desired signal and heard in the receiver's output. Even though the sizes of IF components and conductors are small compared to the wavelength of unwanted signals, the gain of modern active parts can be extremely high. As a result, IFs can respond to unwanted signals coupled through incredibly small antennas. For example, a telephone handset can pick up HF transmissions, even with a filter in the telephone cord.

All Radios Are Not Created Equal!

There are considerable differences in IMD performance among different radios. Many of these differences result from the radio design. A single-band radio that cannot receive frequencies outside that ham band usually offers good rejection of interference from nonham frequencies. Some radios have tracking filters in the front end that automatically pass the frequency a user selects. Other differences in performance can result from the specific design of front-end or mixer circuits.

The ARRL Laboratory performs an extensive battery of tests on all equipment featured in the Product Review column. One of those tests is a wide-band dynamic-range test on VHF equipment, using two strong signals just outside the amateur band (usually the abode of nearby pager transmitters). This test is a good indicator of relative IMD performance. QST lists the result in the Product Review table as "Two-tone, third-order dynamic range, 10-MHz offset."

The November 1995 Product Review column compared eight dual-band FM H-Ts. The 10-MHz dynamic range varied quite a bit from radio to radio, ranging from 73 dB to 91 dB.

Why are they different? Many factors combine to affect a radio's IMD performance. Most VHF receivers are designed to be very sensitive because they will be used with inefficient "rubber ducky" or short

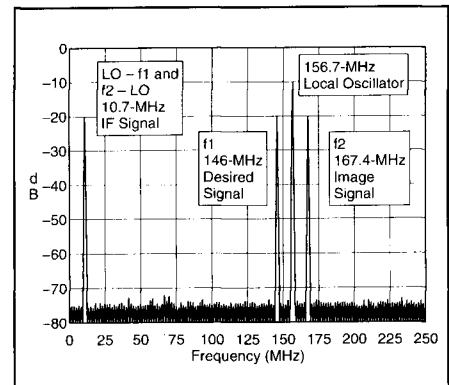

Figure 4—A superheterodyne receiver can respond to signals other than the desired signal. If the RF selectivity of the receiver is inadequate (poor image rejection), the receiver could hear the signal on 167.4 MHz in addition to the desired signal on 146 MHz.

mobile whip antennas. Unfortunately, this sensitivity can make the receivers prone to overload, especially when used with good outdoor antennas in urban areas.

Band-Pass Versus Broadband Designs

Radios designed to receive only ham-band signals contain a band-pass filter in the RF stages. This filter significantly reduces out-of-band signals, such as those from pagers. Most ham-band-only equipment is fairly immune to IMD problems.

Many hams want to use their VHF equipment as general-coverage VHF receivers, however, to monitor the police, fire and aircraft bands. Although this is convenient, it usually means that these receivers have broadband front ends. A broadband front end offers little protection against many interfering signals. It may be nice to have a radio that tunes from "dc to daylight," but that convenience may come with an unwanted price: The resultant combination of harmonic distortion, poor IF-image rejection and IMD problems can make the radio unusable in some areas.

Some receiver designs combine the best of both worlds: *Tracking* front ends automatically tune the RF stage to pass the desired frequency. Thus, when you use the receiver on 146 MHz, the front-end filter passes 146 MHz and offers some rejection to paging signals near 152 MHz, for example.

External Filters

External filters can significantly improve the IMD performance of existing radios. These filters are usually either band-pass or band-reject (notch) designs. Several companies sell filters designed to solve IMD problems.

Band-Pass Designs

Band-pass filters do just what the name implies—they pass a band of frequencies and attenuate all others. A well-designed filter can exhibit less than 1 dB of loss inside the passband and up to 60 dB or more attenuation outside the passband. Figure 5 shows two commercial band-pass filters. (Any of these filters will help reduce IMD problems.) The large filter at the bottom of the photograph is a helical band-pass filter made by DCI.¹ The ARRL Laboratory measured 0.8 dB insertion loss (a fraction of an S unit) and about 55 dB of attenuation at pager frequencies. This filter would make an excellent IMD filter for a base or mobile station. It is much too large to use with a H-T, however. Its band-pass characteristics are similar to those in Figure 6. It filters on transmit as well as receive, offering some additional EMI prevention as a bonus.

Tucker Electronics² sells the smaller filter shown in the lower left of Figure 5. It requires an external dc power supply, and you must switch it off line manually or via the built-in RF-sensing circuit before transmitting. It has 6 dB of insertion loss on re-

A 2-Meter Notch Filter You Can Build

Having trouble with VHF pager interference? The notch filter in Figure A can remove signals just above the 2-meter amateur band, without significantly degrading 2-meter signals. As a bonus, it notches out some FM broadcast signals as well. The filter has a notch depth of 27 dB, with 0.5 dB of insertion loss.

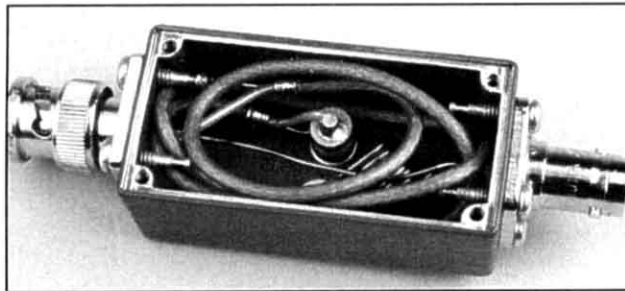

Figure A—This simple notch filter is easy to tune and uses available components.

The design is fairly straightforward. L1 and C2 form a 152-MHz series-resonant circuit to reflect 152-MHz signals. C2 sets the notch frequency. As the frequency decreases below 152 MHz, the circuit becomes capacitive. We prevent the capacitive circuit from disturbing 2-meter signals by adding inductive reactance to form a 2-meter parallel-tuned circuit. We could do this with a tunable inductor, but a variable capacitor and a transmission-line section (C1/TRL1) are more practical. As a bonus, the capacitor and transmission line form another series-resonant circuit, which rejects signals in the FM broadcast band.

This design assumes that you want a notch above the 2-meter band. For a notch below the 2-meter band, the unwanted reactance would be inductive, which would require only a capacitor to obtain parallel resonance. This would eliminate TRL1.

The filter is bidirectional—it works both ways. I have assumed that you would attach it directly to a BNC connector on an H-T.

Construction

If cost isn't a factor, build this circuit in a Pomona 2391 die-cast aluminum box that comes with male and female connectors (available from Newark Electronics).[†] Male BNC panel-mount connectors can be difficult to locate.

RF grounding is important. To establish good electrical contact to the capacitors, I first removed the paint by lightly drilling the chassis with a Black and Decker 5/16-inch "bullet" drill bit. I then enlarged the holes (with an ordinary 1/4-inch drill bit) to mount the capacitors. Similarly, scrape off the paint underneath the connectors for good electrical contact. I prepared RG-188 Teflon coax for TRL1 as shown in Figure B. RG-174 will work just as well, but it is easy to melt the RG-174 dielectric and short the cable while soldering.

Alignment

C2 controls the notch frequency; adjust it first. Even with an expensive piston trimmer, the notch in tuning is rather sharp—use a high-quality capacitor.

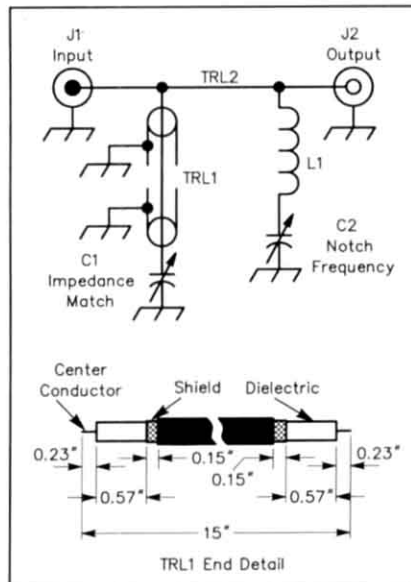

Figure B—Schematic of a pager notch filter that allows undisturbed 2-meter reception.

- C1, C2—1 to 14 pF 5402PC Johanson air-dielectric variable capacitors (Newark No. 17F161; minimum Q is 3000 at 100 MHz).
- J1—Male BNC connector. See text.
- J2—Female BNC connector.
- TRL1—15 inches RG-188 Teflon coax with ends prepared as shown.
- TRL2—1.75 inches, #18 AWG enameled wire between coaxial jacks (to hook the connectors together).

Next, tune C1 for best SWR. It should not affect the notch frequency, although C1 may need retuning if you change the notch frequency. Use an H-T and an SWR meter or return-loss bridge^{††} to tune C1.—Zack Lau, KH6CP/1, ARRL Senior Lab Engineer

[†]Newark Electronics, Inc., 4801 N Ravenswood Ave., Chicago, IL 60640-4496; tel 312-784-5100.

^{††}A suitable return-loss bridge circuit appears in the April 1996 QST on page 76.

¹Notes appear on page 43.

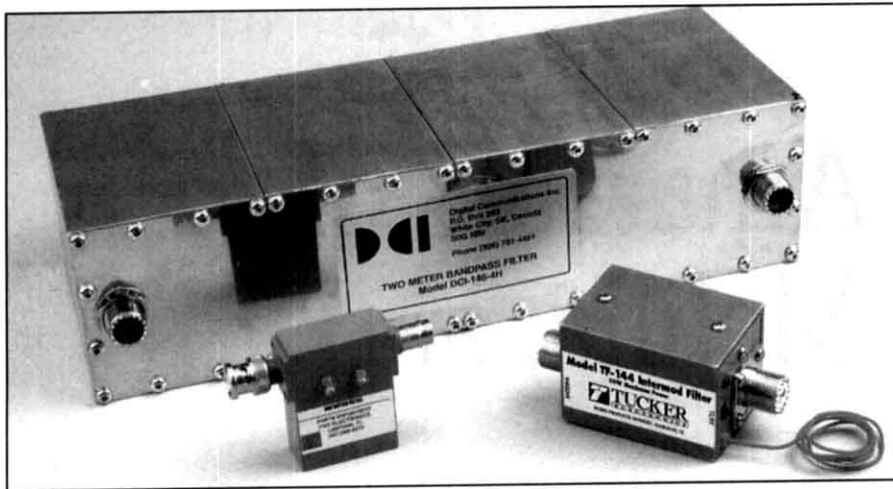

Figure 5—Two of the three shown are band-pass filters (discussed here). One of them is a notch filter (discussed later). All three are commercial.

ceive and offers up to 55 dB of attenuation at pager frequencies. It is small, and its BNC connectors mount it to an H-T easily. It is relatively easy to find the 30 mA of dc current required to operate the RF switch and internal relay.

Although up to 6 dB of insertion loss may seem excessive, most local FM signals are much stronger than 6 dB above the local noise. They will still fully quiet the receiver even when reduced 6 dB by the filter. More important, the filter removes third-order IMD from 150 to 160-MHz signals, allowing successful contacts on an otherwise unusable radio.

Notch Filters

Most 2-meter IMD problems are true IMD cases: third-order distortion from pager transmitters. Pagers near 2 meters operate from 152 to 156 MHz. If these are your only problem, a notch filter on your receiver will eliminate the IMD interference. Figure 5 (lower right) shows a notch filter made by Par Electronics³ at the lower right. It has 0.2-dB insertion loss on 2 meters and 45-dB attenuation at 152 MHz. It is entirely passive and suited for use with H-Ts, base or mobile equipment. It does not protect against interference problems caused by transmitters other than 152 to 156-MHz pagers, though.

If you like to build your own accessories, see the sidebar "A 2-Meter Notch Filter You Can Build."

Attenuation

In some cases, a simple attenuator can help reduce IMD problems. Third-order IMD has an unusual property: When you reduce the level of a signal causing a third-order product by 1 dB, you reduce the third-order product by 3 dB. In cases where the desired signal fully quiets the receiver and yet is masked by IMD, a 10-dB attenuator placed between the receiver and antenna reduces the desired signal by 10 dB and the IMD by 30 dB! In many cases, a 10-dB re-

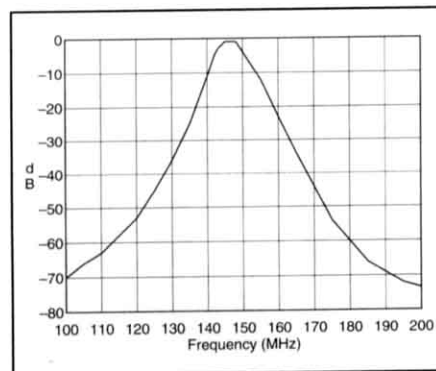

Figure 6—The frequency response of a typical band-pass filter. This filter's passband centers near 147 MHz. Its 3-dB bandwidth is about 7 MHz (143 to 150 MHz).

duction of the desired signal won't matter, but a 30-dB reduction of the IMD product makes the contact possible.

A directional antenna, such as a Yagi, is an "attenuator" solution to IMD problems that is sometimes overlooked. This solution is useful when the IMD source and desired signal come from different directions. Orient the antenna for either maximum desired-signal strength or minimum IMD.

External IMD

So far, I've discussed only IMD that occurs in an overloaded receiver. In rare cases, IMD can happen outside of the receiving system. Although a repeater receiver is prone to the same IMD problems as any other receiver, the repeater duplexer usually offers some protection from overload. (However, it may not be enough for pagers located on the same site!) Because of this protection, IMD to repeater systems sometimes comes from sources external to the receiver. Any nonlinear system or device can act as a mixer, generating harmonics and IMD. Once IMD is generated, any significant (say,

0.1 λ) conductor connected to the nonlinear device will act as an antenna and radiate the signals, perhaps over a large area.

When talking about external IMD, most hams immediately think of the "rusty-bolt effect." Any poor electrical joint between two conductors can act as a diode mixer, so many hams blame rusty towers, gutters and downspouts for external IMD. In reality, this is rarely the case. Look for external IMD very close to one or both of the transmitters and then very close to the receiver. Locate external problems with direction-finding techniques.

One or more transmitters at a site can be the source of the problem. Strong signals from the antenna can mix in a transmitter output circuit, then be radiated from the antenna. Transmission-line stubs or additional filter cavities can reduce the unwanted signals.⁴

The ARRL has two books that pick up where this article leaves off. *Radio Frequency Interference—How to Find It and Fix It* covers a wide range of interference problems. *Transmitter Hunting* explains a number of direction-finding techniques that can be applied to external IMD problems.⁵

Notes

¹DCI Digital Communications, Inc, PO Box 293, White City, SK, Canada, S0G 5B0; tel 306-781-4451; e-mail dc@dc.ca Web site: <http://www.dci.ca>.

²Tucker Electronics Inc, PO Box 551419, Garland, TX 75355-1419; tel 800-527-4642 (for test equipment and catalog requests), tel 800-559-7388 (radio orders), fax 214-340-5460; Web site: <http://www.tucker.com>

³Par Electronics, 6869 Bayshore Dr, Lantana, FL 33462; tel 407-586-8278; fax 407-582-1234.

⁴For more information about tuned stubs, look in *Radio Frequency Interference: How to Find It and Fix It*. You'll find them in the index under "Filters: Tuned stubs." A basic discussion of cavity (transmission-line) filters appears in Chapter 16 of the 1995 and 1996 *ARRL Handbook*.

⁵Ordering information for *Radio Frequency Interference: How to Find It and Fix It* (Order No. 3754), *Transmitter Hunting* (Order No. 2701) and *Interference Handbook* (Order No. 6015) appears in the *ARRL Publications Catalog* elsewhere in this issue.

Ed Hare, KA1CV, was first licensed in 1963 and upgraded to Extra Class in the mid 1970s. He has been with ARRL Headquarters for 10 years and holds the position of Laboratory Supervisor. Over the years, Ed has written many EMI articles, ranging from QST "Lab Notes" to The ARRL Handbook to articles that have appeared in professional trade journals. He is also one of the editors and authors of ARRL's Radio Frequency Interference: How to Find It and Fix It. Ed is very active in several EMC programs at ARRL. He is a member of the Society of Automotive Engineers EMC Committee and the American National Standards Institute C.63 Committee, which develops standards for the immunity of consumer equipment and motor vehicles.

Ed's Amateur Radio interests are HF mobile CW and QRP operations. Ed has worked about 1000 US counties with 5 W, holds 250-mW WAS and is working on 10-mW WAS. You can contact Ed at ARRL Headquarters (see page 10 of this issue).

